

988K XE

Wheel Loader



Engine

Engine Model	Cat® C18 ACERT™	
Emissions	U.S. EPA Tier 4 Final/ EU Stage IV	
Gross Power – ISO 14396	432 kW	580 hp
Net Power – SAE J1349	403 kW	541 hp
Buckets		
Bucket Capacities	4.7-13 m ³	6.2-17 yd ³

Operating Specifications

Rated Payload – Standard (face material)	11.3 tonnes	12.5 tons
Rated Payload – Standard (loose material)	14.5 tonnes	16 tons
Rated Payload – High Lift (face material)	11.3 tonnes	12.5 tons
Rated Payload – High Lift (loose material)	14.5 tonnes	16 tons
Operating Weight – Standard	52 781 kg	116,362 lb
Operating Weight – High Lift	54 258 kg	119,618 lb

Lower your cost per ton with industry leading efficiency.



Contents

- Efficiency.....4
- Power Train.....6
- Structures.....8
- Hydraulics10
- Operator Station.....12
- Technology Solutions14
- Serviceability.....15
- Customer Support.....15
- Safety16
- Sustainability18
- System Match Efficiency.....19
- Bucket Ground Engaging Tools20
- Specifications.....22
- Standard Equipment.....30
- Optional Equipment.....31
- Mandatory Attachments.....32



Cat® Large Wheel Loaders are designed with durability built in, ensuring maximum availability through multiple life cycles. With optimized performance and simplified serviceability, our machines allow you to move more material efficiently and safely at a lower cost per ton.

Introduced in 1963, the 988 has been the industry leader for over 50 years, built on a legacy of reliability, performance, safety, operator comfort, serviceability, and productivity. The 988K XE brings improved sustainability and maximum efficiency to this machine platform.

Efficiency

Delivering fuel efficiency you demand through electric drive technology.





While the electric drive transmission replacement on the 988K enables the significant increase in efficiency, the axles and the driveline are the same as on the proven 988K mechanical drive.

Cat C18 ACERT™ Engine

The Cat C18 ACERT engine is built and tested to meet your most demanding applications while meeting Tier 4 Final/Stage IV emission standards.

- Fully integrated electronic engine controls works in concert with the entire machine to make your fuel go farther.
- Use less fuel idling with Engine Idle Shutdown.
- Maximized durability with Delayed Engine Shutdown.



Fuel Efficiency

Enabling maximum productivity and efficiency, all day every day.

The 988K XE systems work hard to make you more efficient through advanced electric drive technology.

- Overall efficiency improvement of 25 percent.
- Efficiency improvement of up to 49 percent in tough applications.
- Up to a 10 percent increase in productivity in load and carry applications.

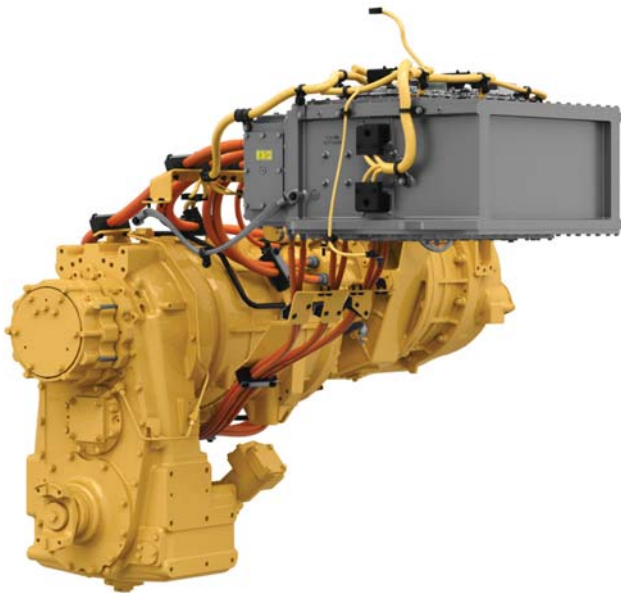

Cat Switched Reluctance Electric Drive System

- Continuously variable speed control up to maximum ground speed.
- Implemented virtual gears for machine controllability.
- Automatic retarding controls for maintaining speed on grade.
- Extended maintenance intervals over mechanical power trains.
- Fewer moving parts than traditional torque converter and mechanical transmission systems.
- Elimination of the shifting simplifies operator controls thus accelerating the learning curve of new operators.

Cat Switched Reluctance Electric Generator and Pump Drive

- Fewer moving parts than traditional torque converter systems.
- Extended maintenance intervals over mechanical power trains.
- Integrated controls provide power on demand.
- Integrated pump drive for seamless hydraulic performance.

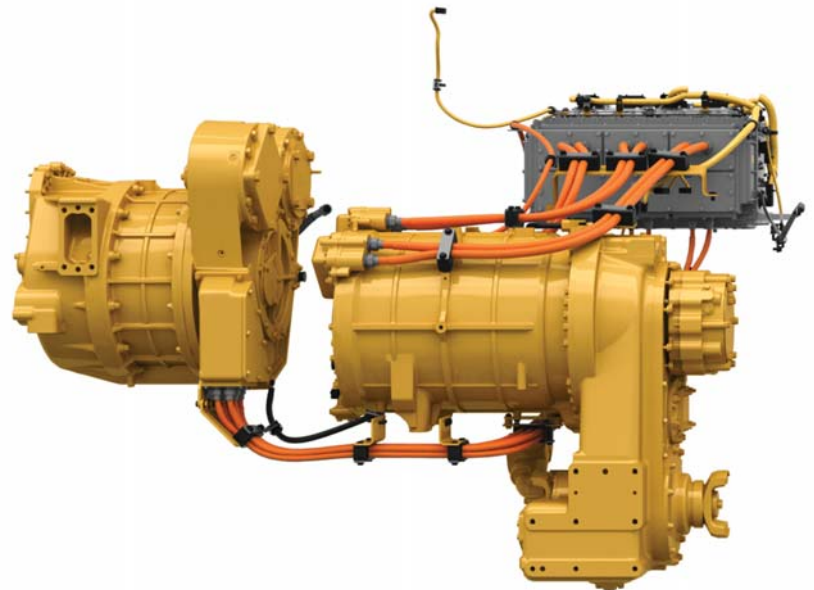

Cat Integrated Powered Electronics

- Fully sealed to protect from the elements.
- Liquid cooled to extend component life.
- Solid state components maximize durability in extreme conditions.

Cat Switched Reluctance Electric Drive Motor

- Continuously variable speed control up to maximum ground speed.
- Implemented virtual gears for machine controllability.
- Automatic retarding controls for maintaining speed on grade.
- Extended maintenance intervals over mechanical power trains.

Steering and Transmission Integrated Control System (STIC™)

Experience maximum responsiveness and control with STIC that combines directional selection, virtual gears and steering into a single lever.

Power Train

Move material more efficiently with improved power and control.



Variable Torque Control and Rimpull Control System (RCS)

Lower your cost per ton utilizing advanced torque control and RCS for modulated rimpull.

- Reduce tire slippage and wear by modulating rimpull from 100 to 25 percent while depressing left pedal. After 25 percent rimpull is achieved the left pedal applies the brake.
- Reduce the potential for wheel slippage without reducing hydraulic efficiency with RCS.

Automatic Retarding Controls

- Maintain operator safety and efficiency by controlling speed on grade.
- Machine sets maximum allowable speed.
- Operator controls speed up to maximum allowed.

Structures

Best built for the toughest conditions.



Lift Arms

- Excellent visibility to the bucket edges and work area through a Z-bar design.
- High load stresses are absorbed by the solid steel lift arms.
- Enhance strength in key pin areas through the use of one piece castings.
- Stress relieved lift arms increase durability and lengthen time to repair.



Robust Structures

Your bottom line is improved by highly durable structures that achieve multiple life cycles and withstand the toughest loading conditions.

- Full box-section rear frame resists torsional shock and twisting forces.
- Heavy-duty steering cylinder mounts efficiently transmit steering loads into the frame.
- Axle mounting has been optimized for increased structural integrity.
- Lower hitch pin, frame plate, and bearing size have been increased for longer life.



Front Linkage

To ensure long life and reliability, the linkage pin joints feature a greased pin design with an auto lube system attachment available from the factory.



Hydraulics

Productivity enabling you to move more and make more.



Positive Flow Control Hydraulics

Increase efficiency through our Positive Flow Control (PFC) Hydraulic System. PFC has concurrent pump and valve control. By optimizing pump control, hydraulic oil flow is proportionate to implement lever movement.

- Fast, productive cycles are enabled by the fully variable implement pump.
- Increase bucket feel and control through increased hydraulic response.
- Consistent performance and efficiency with lower system heat.
- Full hydraulic flow down to 1,400 engine rpm enabled by flow sharing technology.

Electro Hydraulic Controls

Operators increase productivity with our responsive implements feature.

- Operate comfortably through electronically controlled hydraulic cylinder stops.
- Handle easy-to-use soft detent controls.
- Conveniently set automatic implement kickouts from inside the cab.

Steering System

Confident loader operation starts with precise machine control enabled by the 988K XE's load sensing hydraulic steering system.

- Increase efficiency with our variable displacement piston pumps.
- Achieve precise positioning for easy loading in tight areas with 43 degrees of steering articulation.
- Enhance operator comfort with integrated steering and transmission control functions.

Filtration System

Benefit from extended performance and reliability of your hydraulic system with our advanced filtration system.

- Case drain screens.
- Hydraulic oil cooler return filter.
- Pilot filter.
- In-tank return screens.
- Axle oil cooler screens if equipped.



Your operators can work more efficiently and stay comfortable with our customer-inspired cab features.

Entry and Exit

Enter and exit the cab easily and safely with these newly designed, ergonomic features.

- Fold up STIC steer/armrest.
- 45 degree access stairway angles.
- Standard stairway lighting.



Deluxe Operator Seat

Enhance comfort and helps reduce operator fatigue with Cat Comfort Series III seat.

- Heated and ventilated seat featuring leather seat bolster surfaces.
- High back design and extra thick, contoured cushions.
- Air suspension system.
- Easy-to-reach seat levers and controls for six way adjustments.
- Seat-mounted implement pod and STIC steer that moves with the seat.
- 76 mm (3 in) wide retractable seat belt.



Control Panel

Ergonomic placement of switches and information display keep your operators comfortable all day every day.

- Large backlit membrane switches feature LED activation indicators.
- Switches feature ISO symbols for quick function identification.
- Two position rocker switch activates the electro hydraulic park brake.

Operator Station

Best-in-class operator comfort and ergonomics.



Environment

Your operator's productivity is enhanced with our clean, comfortable cab environment.

- Experience reduced vibrations from isolated cab mounts and seat air suspension.
- Maintain desired cab temperature with automatic temperature controls.
- Pressurized cab with filtered air.
- Low operator sound levels.
- Convenient floor storage tray/lunch box.

Technology Solutions

Greater productivity through
Integrated Electronic Systems.

Integrated electronics provide flexible levels of information to both the site and the operator. This integration creates a smart machine and more informed operator, maximizing the productivity of both.

Information Display

We have worked hard to help our customers and operators perform at their best through our newly upgraded touch screen information display.

- Intuitive operation and easy navigation with our enhanced user interface.
- Decrease service time by keeping operators informed about machine systems.

Vital Information Management System (VIMS™)

Connect directly to the machine for access to a wide range of sensor information and enhanced machine data.

- Create productivity reports with payload and work cycle segmentation.
- Identify operator training needs through productivity data.
- Detailed data logging of machine parameters and diagnostic codes.
- Track machine sensor information with trend analysis and histograms to monitor machine health.

Tire Pressure Monitoring System (TPMS)

Tire pressure monitoring is a fully integrated feature which allows operators to monitor inflation of tires. Available through the Information Display, the operator can quickly see the current pressure settings and temperature of each tire.

Cat Production Measurement (CPM)

Cat Production Measurement brings payload weighing to the cab so operators can work more productively and deliver accurate loads with confidence. CPM brings advanced weighing modes which assist with payload accuracy and speed the loading cycle.

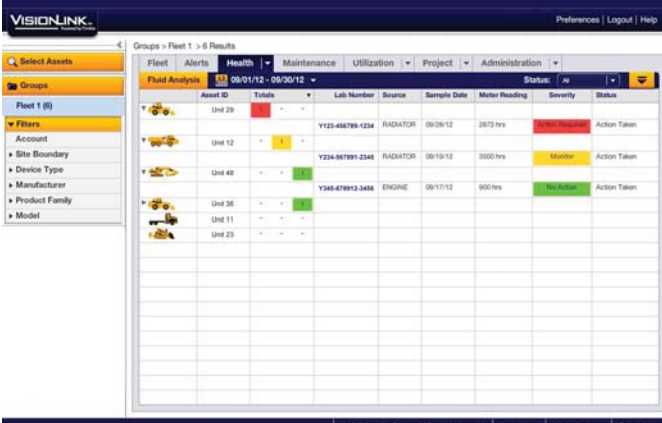

The screenshot shows the VISIONLINK software interface. The top navigation bar includes 'VISIONLINK' and 'Preferences | Logout | Help'. Below the navigation bar, there are tabs for 'Fleet', 'Alerts', 'Health', 'Maintenance', 'Utilization', 'Project', and 'Administration'. The main content area displays a table of asset data under the heading 'Groups > Fleet 1 > 6 Results'. The table has columns for 'Asset ID', 'Totals', 'Lab Number', 'Source', 'Sample Date', 'Meter Reading', 'Severity', and 'Status'. The data rows show various units with their respective metrics and status indicators.

Asset ID	Totals	Lab Number	Source	Sample Date	Meter Reading	Severity	Status
Unit 25							
Unit 12		Y123-456789-1234	RADIATOR	08/26/12	2873 hrs	Critical	Action Taken
Unit 45		Y234-567891-2345	RADIATOR	08/19/12	8500 hrs	Monitor	Action Taken
Unit 36		Y345-678912-3456	ENGINE	08/17/12	900 hrs	Test Action	Action Taken
Unit 11							
Unit 23							

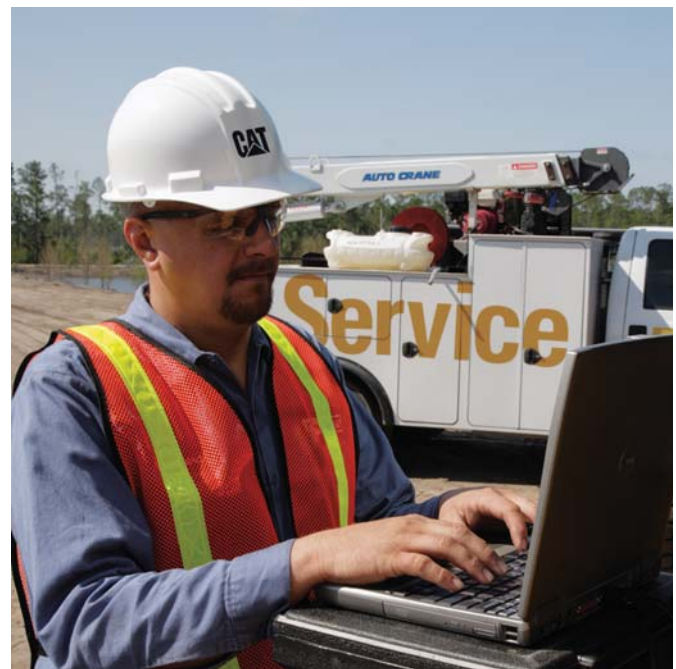

Serviceability

Enabling high uptime by reducing your service time.

We can help you succeed by ensuring your 988K XE has design features to reduce your downtime.

- Efficient electric drive design:
 - Increases engine life, extending time between power train rebuilds
 - Two times the life for power train oil and four times the life for filters
 - Reduces power train rebuild cost
- Durable SR drive motor, generator, and inverter are built to last through the second engine life, with only the motor and generator requiring the seals and bearings be replaced at the first engine overhaul.
- Hazardous voltage lamp to assure electric drive system is de-energized and machine is safe to work on.
- Safe and convenient service with ground level or platform access and grouped service points.
- Swing-out doors on both sides of the engine compartment provide easy access to important daily service checks.
- Ecology drains for ease of service and prevention of spills.
- Reduce downtime with VIMS system notifications so your operators and technicians can resolve any problems before failure.

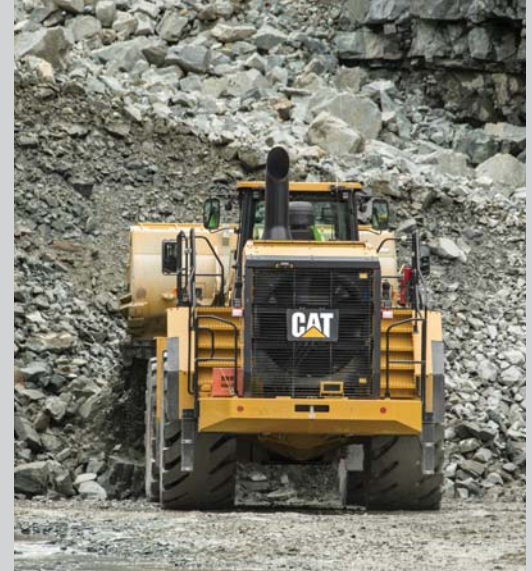

Customer Support

Your Cat dealers know how to keep your machines productive.



Legendary Cat Dealer Support

A valued partner, your Cat dealer is available whenever you need them.

- Preventive maintenance programs and guaranteed maintenance contracts.
- Best-in-class parts availability.
- Improve your efficiency with operator training.
- Genuine Cat Remanufactured parts.

Safety

Making your safety our priority.



We are constantly improving our products in an effort to provide a safe work environment for the operator and those who work on your job site.

Machine Access

- Left and right hand stairs with 45 degree angle enhance safety for operators getting on and off the 988K XE.
- Continuous walkway with non-skid surfaces are designed into the service areas.
- Maintain three points of contact at all times through ground level or platform accessible service areas.



Visibility

- Optional heated mirrors ensure enhanced visibility for safe operation.
- Standard Cat Vision or optional Cat Detect with radar increase operator awareness around the machine.
- Optional HID or LED lights provide excellent workspace visibility.
- Optional cab mounted LED warning beacons.

Operator Environment

- Reduced vibrations to the operator with isolated cab mounts and seat mounted implement and steering controls.
- Low interior sound levels.
- Pressurized cab with filtered air.

Sustainability

Stewards of the environment.



Reducing the Impact to the Environment

Sustainability is designed and built into our 988K XE.

- Maintain the productivity of a 988K mechanical drive machine while operating 25 percent more efficiently.
- Economy Mode further reduces fuel consumption with minimal impact to productivity.
- Engine Idle Shutdown can help you save fuel by avoiding unnecessary idling.
- Reduce waste with our maintenance free batteries.
- Built for multiple lives, the Cat 988 is one of the most rebuilt products. To assist with maximizing machine life, Caterpillar provides a number of options such as our Reman and Certified Rebuild programs. In these programs, reused or remanufactured components can deliver cost savings of 40 to 70 percent, which lowers operating cost while reducing waste.
- Electric drive system maximizes consumable life, reducing oil and filter waste.

System Match Efficiency

Efficient loading/hauling system starts with a perfect match.



	770	772	773	775
Standard Lift	3	4		
High Lift			5	6

Efficient Combination

For full truck payloads with minimum loading time, an efficient loading/hauling system starts with a perfect match. Cat wheel loaders are matched with Cat off-highway trucks to maximize volume of material moved at the lowest operating cost per ton. The 988K XE equipped with the standard linkage will pass match the 770 (36 tonnes/40 tons) in 3 passes and the 772 (45 tonnes/50 tons) in 4 passes. Equipped with a high lift linkage the 988K XE is capable of loading a 773 (56 tonnes/61.7 tons) in 5 passes and the 775 (64 tonnes/70 tons) in 6 passes.

Bucket Ground Engaging Tools

Protect your investment.

Enhance the productivity of your loader and protect your investment in buckets with our Ground Engaging Tools (GET). Your knowledgeable Cat dealer will work with you to understand your application and needs for the GET that is best for you.

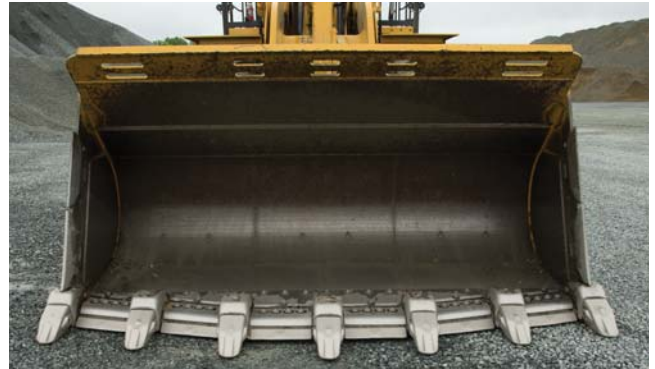

1 – Rock Buckets

Designed for use in bank or face loading of limestone and other unprocessed rock. Application also includes truck and hopper loading for a wide range of quarry materials. GET includes spade nose cutting edge with adapters, half arrow segments, bottom wear plates, and sidebar protectors.

2 – Heavy Duty Rock Buckets

Designed for use in applications like face loading tightly compacted pit materials or handling materials of moderate abrasion and high impacts. GET are similar to the rock bucket with the addition of floor liner, half radius liners and bolt-on bottom edge wear plates. 20-series mechanically attached wear plates (MAWPS) are provided for additional wear protection and improved serviceability. Base edge end protection, ski plates, additional side wear plates, wings and an extra set of sidebar protectors are also included.

3 – General Purpose Buckets

Designed for use primarily in stockpiling, re-handling and aggregate applications. GET includes a straight base edge with a bolt-on cutting edge system. Curved sidebars are provided to aid in material retention on the 12.5 yard (9.6 cubic meters) aggregate bucket only.

4 – Coal Buckets

Designed with a larger capacity for use in applications with light density and non-abrasive materials. GET includes a straight base edge with a bolt-on cutting edge system.

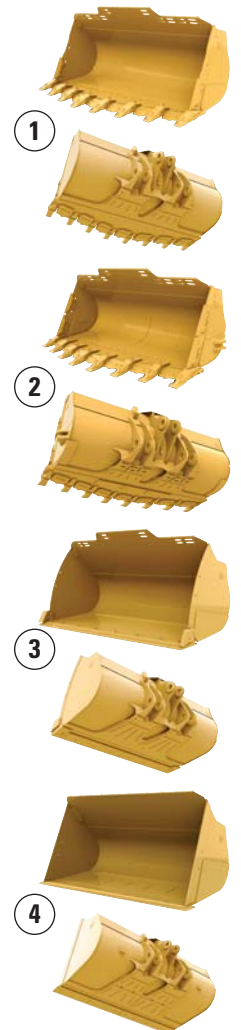

Cat Advansys™ Ground Engaging Tools

Protect expensive components. Reduce your operating costs. Get the most out of your machine's performance. Choose from a variety of performance-built Advansys GET like these to meet your application requirements.

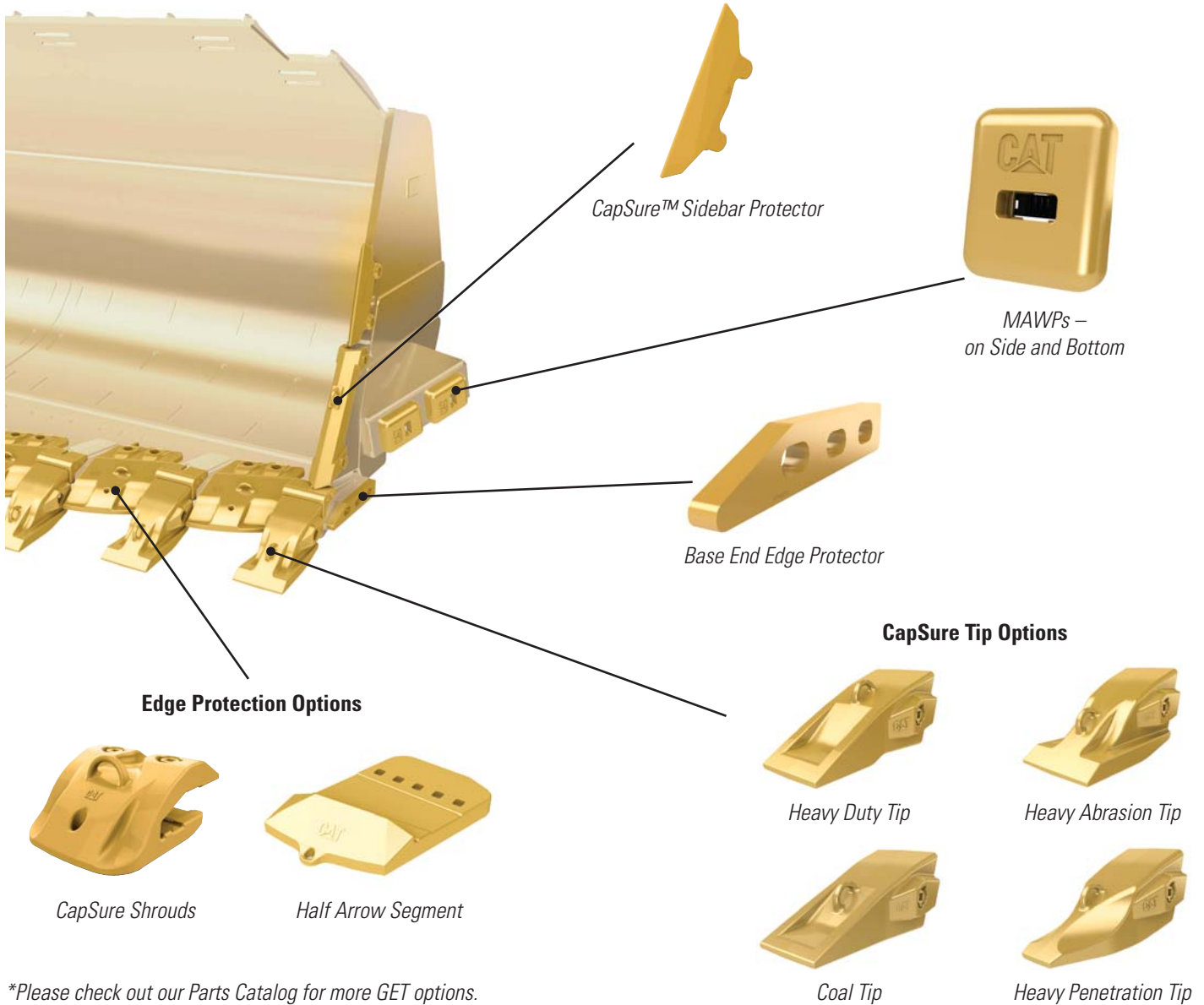

*Please check out our Parts Catalog for more GET options.

CapSure™ Retention Technology

Simplify GET component replacement with hammerless CapSure retention for fast, easy and safe installation. CapSure tips, shrouds and sidebar protectors are easily locked and unlocked with a 180 degree turn of a 3/4 inch (19 mm) ratchet.

988K XE Wheel Loader Specifications

Engine

Engine Model	Cat C18 ACERT	
Emissions	Tier 4 Final/Stage IV	
Rated Speed	1,700 rpm	
Peak Power Speed	1,500 rpm	
Gross – ISO 14396	432 kW	580 hp
Gross – SAE J1995	439 kW	588 hp
Net Power – SAE J1349	403 kW	541 hp
Bore	145 mm	5.7 in
Stroke	183 mm	7.2 in
Displacement	18.1 L	1,105 in ³
Peak Torque @ (speed) – SAE J1995	2852 N·m	2,104 lbf·ft
Torque Rise	58%	

Air Conditioning System

The air conditioning system on this machine contains the fluorinated greenhouse gas refrigerant R134a (Global Warming Potential = 1430). The system contains 1.8 kg of refrigerant which has a CO₂ equivalent of 2.574 metric tonnes.

Operating Specifications

Operating Weight	52 781 kg	116,362 lb
Rated Payload – Standard (face material)	11.3 tonnes	12.5 tons
Rated Payload – Standard (loose material)	14.5 tonnes	16 tons
Rated Payload – High Lift (face material)	11.3 tonnes	12.5 tons
Rated Payload – High Lift (loose material)	14.5 tonnes	16 tons
Bucket Capacity Range	4.7-13 m ³	6.2-17 yd ³

Transmission

Transmission Type	Cat switched reluctance electric drive	
Forward 1 (virtual)	7 km/h	4.3 mph
Forward 2 (virtual)	11.3 km/h	7 mph
Forward 3 (virtual)	22.2 km/h	13.8 mph
Forward 4 (virtual)	32.1 km/h	20 mph
Reverse 1 (virtual)	7 km/h	4.3 mph
Reverse 2 (virtual)	11.3 km/h	7 mph
Reverse 3 (virtual)	28.2 km/h	17.5 mph

Hydraulic System Lift/Tilt

Lift/Tilt System – Circuit	EH-Positive Flow Control, Flow Sharing	
Lift/Tilt System Pumps	Variable displacement piston	
Maximum Flow at 1,400-1,600 rpm	580 L/min	153 gal/min
Relief Valve Setting – Lift/Tilt	32 800 kpa	4,757 psi
Lift Cylinder – Bore	210 mm	8.7 in
Lift Cylinder – Stroke	1050 mm	41.3 in
Tilt Cylinder – Bore	269 mm	8.7 in
Tilt Cylinder – Stroke	685 mm	27 in

Operator Cab

ROPS/FOPS	ROPS/FOPS meet ISO 3471:2008 and ISO 3449:2005 Level II standards	
-----------	---	--

988K XE Wheel Loader Specifications

Hydraulic Cycle Time

Rackback	4.5 Seconds
Raise	8 Seconds
Dump	2.2 Seconds
Lower Float Down	3.5 Seconds
Total Hydraulic Cycle Time	18.2 Seconds

Hydraulic System – Steering

Steering System – Circuit	Pilot, load sensing	
Steering System – Pump	Piston, variable displacement	
Maximum Flow @ × 1,400-1,600 rpm	270 L/min	71.3 gal/min
Steering Cut Off Pressure	30,000 kPa	4,351 psi
Total Steering Angle	86	
Steering Cycle Time (high idle)	3.4 sec	
Steering Cycle Time (low idle)	5.6 sec	
Steering	ISO 5010:2007	

Service Refill Capacities

Fuel Tank	555 L	147 gal
Cooling System (jacket water)	112 L	30 gal
Cooling Systems (power train)	30 L	8 gal
Engine Crankcase	60 L	16 gal
Diesel Exhaust Fluid Tank	33 L	8.7 gal
Transmission	60 L	16 gal
Differentials and final drives – front	186 L	49 gal
Differentials and final drives – rear	186 L	49 gal
Hydraulic System – implement/steering	475 L	126 gal

- All non-road Tier 4 Final/Stage IV diesel engines are required to use:
 - The machine has the flexibility to run on either ultra-low-sulfur diesel fuel (ULSD with 15 ppm of sulfur or less) or up to B20 biodiesel when feedstock meeting ASTM D7467 specifications is blended with ULSD.
 - Cat DEO-ULS™ or oils that meet the Cat ECF-3, API CJ-4, and ACEA E9 specifications are required.
 - Only use DEF that meets ISO 22241-1 standards.

Axles

Front	Fixed
Rear	Trunnion
Oscillation Angle	13

Brakes

Brakes	ISO 3450:2011
--------	---------------

Sound Performance – Tier 4 Final/Stage IV

Operator Sound Level (ISO 6396)	72 dB(A)
Machine Sound Level (ISO 6395)	109 dB(A)

- The operator sound pressure level was measured according to the test procedures and conditions specified in ISO 6396:2008. The measurement was conducted at 70 percent of the maximum engine cooling fan speed.
- Hearing protection may be needed when the machine is operated with a cab that is not properly maintained or when the doors or windows are open for extended periods or in a noisy environment.
- The machine sound power level was measured according to the test procedures and conditions specified in ISO 6395:2008. The measurement was conducted at 70 percent of the maximum engine cooling fan speed.

988K XE Wheel Loader Specifications

Dimensions

All dimensions are approximate.

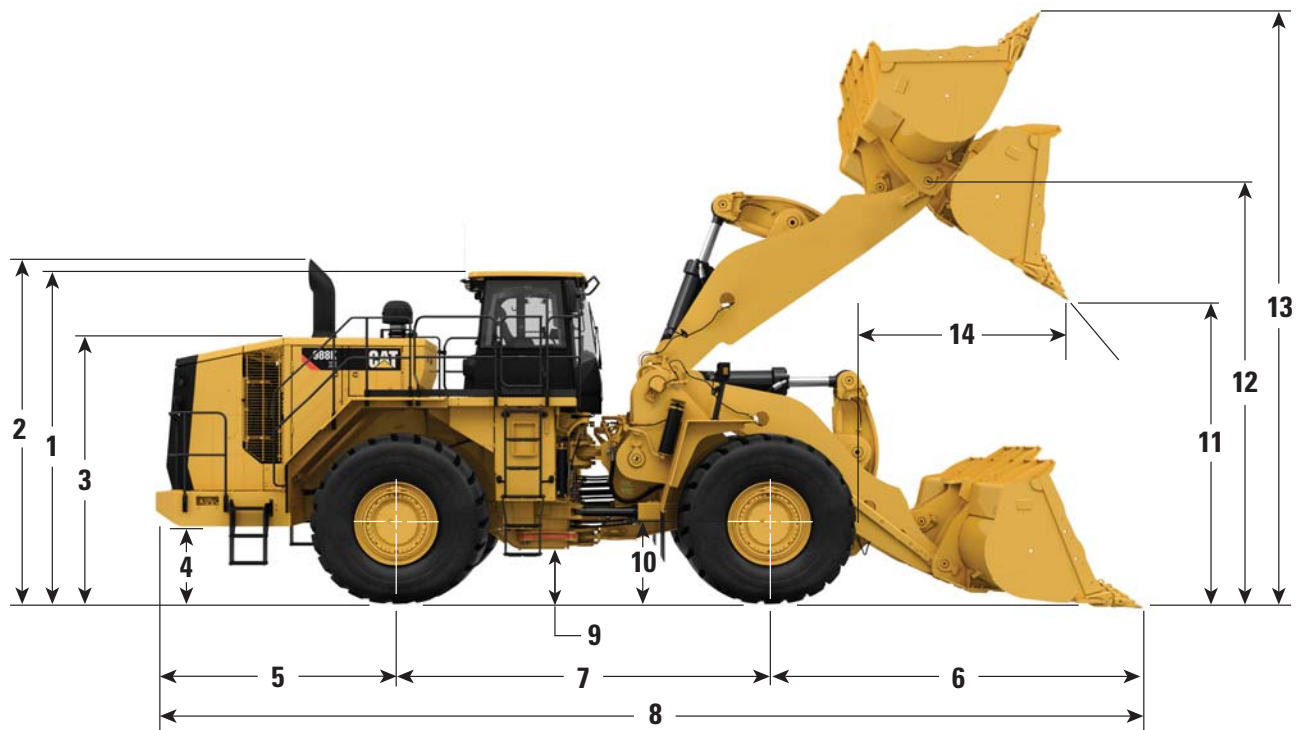

	Standard Lift		High Lift	
	mm	ft	mm	ft
1 Ground to Top of ROPS	4187 mm	13.7 ft	4187 mm	13.7 ft
2 Ground to Top of Exhaust Stacks	4498 mm	14.8 ft	4498 mm	14.8 ft
3 Ground to Top of Hood	3334 mm	10.9 ft	3334 mm	10.9 ft
4 Ground to Bumper Clearance	933 mm	3.1 ft	933 mm	3.1 ft
5 Rear Axle Center Line to Bumper	3187 mm	10.5 ft	3187 mm	10.5 ft
6 Front Axle Center Line to Bucket Tip	4467 mm	14.7 ft	4854 mm	15.9 ft
7 Wheel Base	4550 mm	14.9 ft	4550 mm	14.9 ft
8 Maximum Overall Length	12 204 mm	40.0 ft	12 582 mm	41.3 ft
9 Ground to Lower Hitch Clearance	568 mm	1.9 ft	568 mm	1.9 ft
10 Ground to Center of Axles	978 mm	3.2 ft	978 mm	3.2 ft
11 Clearance at Maximum Lift	3445 mm	11.3 ft	3882 mm	12.7 ft
12 B-Pin Height at Maximum Lift	5479 mm	18.0 ft	5881 mm	19.3 ft
13 Maximum Overall Height – Bucket Raised	7455 mm	24.5 ft	7849 mm	25.8 ft
14 Reach at Maximum Lift	2074 mm	6.8 ft	2130 mm	7.0 ft

Note: Specs are calculated with 6.9 m³ (9.0 yd³) rock bucket and Michelin XLDD2 with 978 mm (3.2 ft) centerline of rear axle height.

Bucket Capacity/Material Density Selection Guide

Standard Lift/High Lift

Rated Payload (Quarry Face) – 11.3 tonnes/12.5 tons

Material Density				Bucket Volume	
kg/m ³	lb/yd ³	tonnes/m ³	tons/yd ³	m ³	yd ³
1468-1614	2,500-2,750	1.47-1.61	1.25-1.38	7.6	10.00
1638-1801	2,778-3,056	1.64-1.80	1.39-1.53	6.9	9.00
1766-1942	3,001-3,300	1.77-1.94	1.50-1.65	6.4	8.33

Standard Lift/High Lift

Rated Payload (Loose Material) – 14.5 tonnes/16 tons

Material Density				Bucket Volume	
kg/m ³	lb/yd ³	tonnes/m ³	tons/yd ³	m ³	yd ³
1510-1667	2,560-2,816	1.51-1.67	1.28-1.41	9.6	12.5
1726-1905	2,909-3,200	1.73-1.90	1.45-1.60	8.4	11
1908-2105	3,200-3,520	1.91-2.11	1.60-1.76	7.6	10

Note: Rated Payload is the material weight in the bucket that the loader is designed to carry, excluding the weight of the bucket, GET, and wear material. Rated Payloads are published at 100 percent, even though Caterpillar does allow 110 percent. These values are given in terms of mass. There is no consideration to loose density weights of various materials since they are so diverse.

988K XE Wheel Loader Specifications

Aggregate Package Operating Specifications – Standard Lift

		988K XE Std Lift Agg Pkg Tires: 35/65 R33 XLDD2, PN: 399-4568 SLR: 978			
		General Purpose			
		Segments			
		Straight			
Bucket Part Number		472-0120	435-4029	347-4990	347-4980
Struck Capacity	m ³	8.0	7.0	6.0	5.5
	yd ³	10.5	9.2	7.8	7.2
Heaped Capacity (Rated)	m ³	9.6	8.4	7.6	6.9
	yd ³	12.5	11	10	9
Bucket Width	mm	3897	3897	3897	3897
	ft	12.8	12.8	12.8	12.8
Dump Clearance at Full Lift and 45° Discharge (Bare)	mm	3642	3741	3818	3902
	ft	11.9	12.3	12.5	12.8
Reach at Lift and 45° Discharge (Bare)	mm	1898	1787	1722	1645
	ft	6.2	5.9	5.7	5.4
Reach with Lift Arms Horizontal and Bucket Level (Teeth)	mm	3917	3768	3668	3554
	ft	12.9	12.4	12.0	11.7
Digging Depth (Segment)	mm	200	208	200	195
	in	7.9	8.2	7.9	7.7
Overall Length (Bucket Level Ground)	mm	11 965	11 822	11 716	11 598
	ft	39.3	38.8	38.4	38.1
Overall Height with Bucket at Full Raise	mm	7830	7688	7591	7487
	ft	25.7	25.2	24.9	24.6
Loader Clearance Turning Circle (SAE Carry with Teeth)	mm	17 406	17 325	17 261	17 192
	ft	57.1	56.8	56.6	56.4
Full Dump Angle	degrees	50	50	50	50
Static Tipping Load Straight (Rigid Tire)*	kg	41 081	41 549	41 949	42 351
	lb	90,567	91,600	92,481	93,367
Static Tipping Load Straight (ISO) (Tire Squash)*	kg	38 427	38 947	39 358	39 783
	lb	84,718	85,863	86,769	87,707
Static Tipping Load – Full Turn (Articulated 35°) (Rigid Tire)*	kg	36 700	37 152	37 543	37 931
	lb	80,909	81,906	82,768	83,624
Static Tipping Load – Full Turn (Articulated 35°) (ISO) (Tire Squash)*	kg	32 635	33 158	33 565	33 987
	lb	71,948	73,100	73,998	74,928
Static Tipping Load – Full Turn (Articulated 43°) (Rigid Tire)*	kg	34 573	35 017	35 404	35 786
	lb	76,220	77,200	78,053	78,894
Static Tipping Load – Full Turn (Articulated 43°) (ISO) (Tire Squash)*	kg	30 105	30 624	31 026	31 441
	lb	66,370	67,514	68,401	69,316
Breakout Force**	kN	381	413	437	468
	lb	85,649	92,746	98,315	105,297
Operating Weight	kg	55 533	55 257	54 969	54 729
	lb	122,428	121,822	121,186	120,656
Weight Distribution at SAE Carry (Unloaded)					
Front	kg	28 451	27 973	27 481	27 064
	lb	62,724	61,671	60,585	59,665
Rear	kg	27 081	27 284	27 488	27 665
	lb	59,704	60,151	60,602	60,992
Weight Distribution at SAE Carry (Loaded)					
Front	kg	51 999	51 403	50 859	50 361
	lb	114,639	113,325	112,125	111,026
Rear	kg	18 048	18 369	18 625	18 883
	lb	39,790	40,497	41,062	41,631

*Static tipping loads and operating weights include full fluids and 80 kg (176 lb) operator.

**Breakout force is measured 102 mm (4 in) behind tip of cutting edge with bucket hinge pin as pivot in accordance with SAE J732C. Full compliance to ISO 14397-1:2007.

988K XE Wheel Loader Specifications

Operating Specifications – Standard Lift

		988K XE Std Lift Tires: 35/65 R33 XLDD2, PN: 399-4568 SLR: 978					
Bucket Type		General Purpose		Rock			HD Rock
Ground Engaging Tool		Adapters or BOCE		X130	X130	X130	X130
Cutting Edge Type		Straight	Straight	Spade	Spade	Spade	Spade
Bucket Part Number		347-4990	347-4980	498-9992	498-9990	498-9988	498-9994
Struck Capacity	m ³	6.0	5.5	6.5	5.5	5.0	5.0
	yd ³	7.8	7.2	8.5	7.2	6.5	6.5
Heaped Capacity (Rated)	m ³	7.6	6.9	7.6	6.9	6.4	6.4
	yd ³	10	9	10	9	8.3	8.3
Bucket Width	mm	3897	3897	4020	4020	4020	4080
	ft	12.8	12.8	13.2	13.2	13.2	13.4
Dump Clearance at Full Lift and 45° Discharge (Bare)	mm	3818	3902	3603	3681	3736	3722
	ft	12.5	12.8	11.8	12.1	12.3	12.2
Dump Clearance at Full Lift and 45° Discharge (with Teeth)	mm	—	—	3414	3492	3547	3520
	ft	—	—	11.2	11.5	11.6	11.5
Reach at Lift and 45° Discharge (Bare)	mm	1722	1645	1936	1858	1803	1816
	ft	5.7	5.4	6.4	6.1	5.9	6.0
Reach at Lift and 45° Discharge (with Teeth)	mm	—	—	2117	2040	1984	1989
	ft	—	—	6.9	6.7	6.5	6.5
Reach with Lift Arms Horizontal and Bucket Level (Teeth)	mm	3668	3554	4233	4123	4045	4067
	ft	12.0	11.7	13.9	13.5	13.3	13.3
Digging Depth (Segment)	mm	200	195	201	201	201	201
	in	7.9	7.7	7.9	7.9	7.9	7.9
Overall Length (Bucket Level Ground)	mm	11 716	11 598	12 281	12 171	12 093	12 115
	ft	38.4	38.1	40.3	39.9	39.7	39.7
Overall Height with Bucket at Full Raise	mm	7591	7488	7557	7455	7381	7384
	ft	24.9	24.6	24.8	24.5	24.2	24.2
Loader Clearance Turning Circle (SAE Carry with Teeth)	mm	17 261	17 192	17 429	17 366	17 321	17 344
	ft	56.6	56.4	57.2	57.0	56.8	56.9
Full Dump Angle	degrees	49.8	49.8	49.8	49.8	49.8	50
Static Tipping Load Straight (Rigid Tire)*	kg	36 029	36 412	35 067	35 604	35 651	34 592
	lb	79,430	80,276	77,309	78,494	78,597	76,262
Static Tipping Load Straight (ISO) (Tire Squash)*	kg	33 859	34 261	32 922	33 477	33 543	32 494
	lb	74,646	75,533	72,580	73,804	73,949	71,636
Static Tipping Load – Full Turn (Articulated 35°) (Rigid Tire)*	kg	32 325	32 697	31 377	31 906	31 946	30 888
	lb	71,263	72,084	69,175	70,340	70,430	68,097
Static Tipping Load – Full Turn (Articulated 35°) (ISO) (Tire Squash)*	kg	29 081	29 478	28 164	28 716	28 783	27 738
	lb	64,112	64,989	62,090	63,309	63,455	61,152
Static Tipping Load – Full Turn (Articulated 43°) (Rigid Tire)*	kg	30 526	30 893	29 586	30 110	30 148	29 090
	lb	67,299	68,108	65,225	66,381	66,465	64,133
Static Tipping Load – Full Turn (Articulated 43°) (ISO) (Tire Squash)*	kg	26 961	27 355	26 053	26 603	26 668	25 626
	lb	59,439	60,308	57,437	58,650	58,793	56,495
Breakout Force**	kN	437	468	371	394	410	402
	lb	98,315	105,297	83,329	88,591	92,170	90,383
Operating Weight	kg	52 334	52 094	52 902	52 559	52 531	53 510
	lb	115,377	114,847	116,628	115,872	115,810	117,969
Weight Distribution at SAE Carry (Unloaded)							
Front	kg	28 687	28 270	29 779	29 144	29 118	30 717
	lb	63,245	62,325	65,652	64,252	64,194	67,719
Rear	kg	23 647	23 824	23 122	23 414	23 413	22 793
	lb	52,132	52,523	50,976	51,619	51,616	50,250
Weight Distribution at SAE Carry (Loaded)							
Front	kg	46 947	46 467	48 073	47 382	47 317	48 922
	lb	103,501	102,441	105,984	104,460	104,317	107,854
Rear	kg	16 727	16 967	16 168	16 516	16 553	15 928
	lb	36,877	37,406	35,645	36,412	36,493	35,115

*Static tipping loads and operating weights include full fluids and 80 kg (176 lb) operator.

**Breakout force is measured 102 mm (4 in) behind tip of cutting edge with bucket hinge pin as pivot in accordance with SAE J732C. Full compliance to ISO 14397-1:2007.

988K XE Wheel Loader Specifications

Aggregate Package Operating Specifications – High Lift

		988K XE High Lift Agg Pkg Tires: 35/65 R33 XLDD2, PN: 399-4568 SLR: 978			
		General Purpose			
		Segments			
		Straight			
Bucket Part Number		472-0120	435-4029	347-4990	347-4980
Struck Capacity	m ³	8.0	7.0	6.0	5.5
	yd ³	10.5	9.2	7.8	7.2
Heaped Capacity (Rated)	m ³	9.6	8.4	7.6	6.9
	yd ³	12.5	11	10	9
Bucket Width	mm	3897	3897	3897	3897
	ft	12.8	12.8	12.8	12.8
Dump Clearance at Full Lift and 45° Discharge (Bare)	mm	4035	4135	4211	4296
	ft	13.2	13.6	13.8	14.1
Reach at Lift and 45° Discharge (Bare)	mm	1987	1876	1811	1734
	ft	6.5	6.2	5.9	5.7
Reach with Lift Arms Horizontal and Bucket Level (Teeth)	mm	4256	4107	4007	3893
	ft	14.0	13.5	13.1	12.8
Digging Depth (Segment)	mm	219	227	219	214
	in	8.6	8.9	8.6	8.4
Overall Length (Bucket Level Ground)	mm	12 371	12 227	12 122	12 005
	ft	40.6	40.1	39.8	39.4
Overall Height with Bucket at Full Raise	mm	8224	8082	7985	7881
	ft	27.0	26.5	26.2	25.9
Loader Clearance Turning Circle (SAE Carry with Teeth)	mm	17 741	17 660	17 595	17 525
	ft	58.2	57.9	57.7	57.5
Full Dump Angle	degrees	50	50	50	50
Static Tipping Load Straight (Rigid Tire)*	kg	41 325	41 734	42 110	42 474
	lb	91,106	92,008	92,837	93,638
Static Tipping Load Straight (ISO) (Tire Squash)*	kg	32 825	39 289	39 678	40 068
	lb	85,594	86,616	87,475	88,334
Static Tipping Load – Full Turn (Articulated 35°) (Rigid Tire)*	kg	36 750	37 149	37 518	37 871
	lb	81,020	81,899	82,713	83,491
Static Tipping Load – Full Turn (Articulated 35°) (ISO) (Tire Squash)*	kg	32 691	33 166	33 554	33 944
	lb	72,072	73,118	73,973	74,833
Static Tipping Load – Full Turn (Articulated 43°) (Rigid Tire)*	kg	34 529	34 923	35 289	35 636
	lb	76,124	76,991	77,798	78,565
Static Tipping Load – Full Turn (Articulated 43°) (ISO) (Tire Squash)*	kg	30 027	30 502	30 888	31 276
	lb	66,198	67,245	68,096	68,951
Breakout Force**	kN	350	380	403	431
	lb	78,782	85,375	90,534	97,000
Operating Weight	kg	58 463	58 187	57 899	57 659
	lb	128,888	128,281	127,646	127,116
Weight Distribution at SAE Carry (Unloaded)					
Front	kg	28 499	28 001	27 486	27 051
	lb	62,830	61,731	60,597	59,638
Rear	kg	29 963	30 187	30 413	30 608
	lb	66,058	66,551	67,049	67,478
Weight Distribution at SAE Carry (Loaded)					
Front	kg	53 223	52 622	52 063	51 558
	lb	117,335	116,013	114,779	113,665
Rear	kg	19 755	20 080	20 351	20 616
	lb	43,552	44,269	44,867	45,451

*Static tipping loads and operating weights include full fluids and 80 kg (176 lb) operator.

**Breakout force is measured 102 mm (4 in) behind tip of cutting edge with bucket hinge pin as pivot in accordance with SAE J732C. Full compliance to ISO 14397-1:2007.

988K XE Wheel Loader Specifications

Operating Specifications – High Lift

		988K XE High Lift Tires: 35/65 R33 XLDD2, PN: 399-4568 SLR: 978					
Bucket Type		General Purpose		Rock			HD Rock
Ground Engaging Tool		Adapters or BOCE		X130	X130	X130	X130
Cutting Edge Type		Straight	Straight	Spade	Spade	Spade	Spade
Bucket Part Number		347-4990	347-4980	498-9992	498-9990	498-9988	498-9994
Struck Capacity	m ³	6.0	5.5	6.5	5.5	5.0	5.0
	yd ³	7.8	7.2	8.5	7.2	6.5	6.5
Heaped Capacity (Rated)	m ³	7.6	6.9	7.6	6.9	6.4	6.4
	yd ³	10	9	10	9	8.3	8.3
Bucket Width	mm	3897	3897	4020	4020	4020	4080
	ft	12.8	12.8	13.2	13.2	13.2	13.4
Dump Clearance at Full Lift and 45° Discharge (Bare)	mm	4211	4296	3997	4074	4130	4116
	ft	13.8	14.1	13.1	13.4	13.5	13.5
Dump Clearance at Full Lift and 45° Discharge (with Teeth)	mm	—	—	3808	3885	3940	3914
	ft	—	—	12.5	12.7	12.9	12.8
Reach at Lift and 45° Discharge (Bare)	mm	1811	1734	2024	1947	1892	1905
	ft	5.9	5.7	6.6	6.4	6.2	6.2
Reach at Lift and 45° Discharge (with Teeth)	mm	—	—	2206	2128	2073	2077
	ft	—	—	7.2	7.0	6.8	6.8
Reach with Lift Arms Horizontal and Bucket Level (Teeth)	mm	4007	3893	4572	4462	4384	4406
	ft	13.1	12.8	15.0	14.6	14.4	14.5
Digging Depth (Segment)	mm	219	214	220	220	220	220
	in	8.6	8.4	8.7	8.7	8.7	8.7
Overall Length (Bucket Level Ground)	mm	12 122	12 005	12 688	12 578	12 500	12 521
	ft	39.8	39.4	41.6	41.3	41.0	41.1
Overall Height with Bucket at Full Raise	mm	7985	7881	7951	7849	7775	7778
	ft	26.2	25.9	26.1	25.7	25.5	25.5
Loader Clearance Turning Circle (SAE Carry with Teeth)	mm	17 595	17 525	17 763	17 699	17 654	17 678
	ft	57.7	57.5	58.3	58.1	57.9	58.0
Full Dump Angle	degrees	50	50	50	50	50	50
Static Tipping Load Straight (Rigid Tire)*	kg	33 846	34 190	32 933	33 427	33 456	32 402
	lb	74,617	75,377	72,605	73,695	73,757	71,434
Static Tipping Load Straight (ISO) (Tire Squash)*	kg	31 957	32 321	31 063	31 576	31 622	30 577
	lb	70,453	71,256	68,482	69,613	69,715	67,411
Static Tipping Load – Full Turn (Articulated 35°) (Rigid Tire)*	kg	30 229	30 566	29 329	29 818	29 842	28 790
	lb	66,644	67,386	64,660	65,737	65,790	63,470
Static Tipping Load – Full Turn (Articulated 35°) (ISO) (Tire Squash)*	kg	27 271	27 634	26 393	26 908	26 958	25 918
	lb	60,121	60,923	58,187	59,323	59,432	57,139
Static Tipping Load – Full Turn (Articulated 43°) (Rigid Tire)*	kg	28 474	28 806	27 580	28 065	28 088	27 036
	lb	62,774	63,507	60,803	61,873	61,923	59,604
Static Tipping Load – Full Turn (Articulated 43°) (ISO) (Tire Squash)*	kg	25 199	25 559	24 330	24 842	24 891	23 852
	lb	55,554	56,347	53,639	54,768	54,874	52,584
Breakout Force**	kN	403	431	341	363	377	370
	lb	90,534	97,000	76,633	81,539	84,840	83,123
Operating Weight	kg	53 806	53 566	54 374	54 031	54 003	54 982
	lb	118,622	118,092	119,873	119,117	119,055	121,214
Weight Distribution at SAE Carry (Unloaded)							
Front	kg	29 321	28 886	30 458	29 797	29 770	31 454
	lb	64,642	63,683	67,148	65,691	65,631	69,344
Rear	kg	24 485	24 680	23 916	24 234	24 233	23 528
	lb	53,980	54,410	52,725	53,426	53,424	51,870
Weight Distribution at SAE Carry (Loaded)							
Front	kg	48 518	48 028	49 689	48 979	48 919	50 609
	lb	106,963	105,883	109,545	107,980	107,848	111,575
Rear	kg	16 628	16 878	16 025	16 391	16 423	15 712
	lb	36,659	37,210	35,328	36,137	36,207	34,640

*Static tipping loads and operating weights include full fluids and 80 kg (176 lb) operator.

**Breakout force is measured 102 mm (4 in) behind tip of cutting edge with bucket hinge pin as pivot in accordance with SAE J732C.

Full compliance to ISO 14397-1:2007.

Standard Equipment

Standard equipment may vary. Consult your Cat dealer for details.

ELECTRICAL

- Alarm, back-up
- Alternator, single 150 amp
- Batteries, dry
- Converter, 10/15 amp, 24V to 12V
- Lighting system (halogen, work lights, access and service platform lighting)
- Starting and charging system, 24V
- Starter emergency start receptacle
- Starter lockout in bumper
- Transmission lockout in bumper
- Hazardous voltage lamp

OPERATOR ENVIRONMENT

- Graphical Information Display, displays real time operating information, performs calibrations and customizes operator settings
- Air conditioner
- Cat Detect Vision, rear vision camera system
- Cab, sound suppressed and pressurized, integrated rollover protective structure (ROPS/FOPS) radio ready for entertainment, includes antenna, speakers and converter (12-volt 5-amp) and power port
- Controls, lift and tilt function
- Heater, defroster
- Horn, electric
- Instrumentation, gauges
 - Coolant temperature
 - Engine hour meter
 - Hydraulic oil temperature
 - Power train oil temperature
- Light, cab, dome
- Lunchbox, beverage holders
- CB radio-ready

- Mirrors, rearview (externally mounted)
- Rimpull Control System
- Seat, Cat Comfort Series III, heated and ventilated, air suspension, six-way adjustable
- Seat belt minder
- Seat belt, retractable, 76 mm (3 in) wide
- STIC Control System
- UV glass
- Virtual gear indicator
- Vital Information Management System (VIMS) with Graphical Information Display: External Data Port, Customizable Operator Profiles, Cycle Timer, Integrated Payload Control System
- Wet-Arm wipers/washers (front and rear)
 - Intermittent front and rear wipers
- Lights, directional

POWER TRAIN

- Brakes, oil-cooled, multi-disc, service/secondary
- Case drain screens
- Electro hydraulic parking brake
- Engine, C18 ACERT MEUI diesel, turbocharged/aftercooled
- Ground level engine shutoff
- Turbine precleaner, engine air intake
- Radiator, Aluminum Modular Radiator (AMR)
- Starting aid, ether, automatic
- Throttle lock, electronic
- Manual switch and automatic fuel priming
- Cat Production Measurement ready
- Cat SR Generator/Pump Drive
- Cat SR Drive Motor
- Cat Integrated Powered Electronics
- Automatic retarding controls

OTHER

- Automatic bucket lift kickout/positioner
- Base machine price includes a rim allowance
- Hydraulically driven demand fan
- Couplings, Cat O-ring face seals
- Doors, service access (locking)
- Ecology drains for engine, radiator, hydraulic tank
- Fuel tank, 555 L (147 gal)
- Hitch, drawbar with pin
- Hoses, Cat XT™
- Hydraulic, steering and brake filtration/screening system
- Cat Clean Emission Module
- Oil sampling valves
- Premixed 50 percent concentration of extended life coolant with freeze protection to -34° C (-29° F)
- Rear access to cab and service platform
- Steering, load sensing
- Toe kicks
- Vandalism protection caplocks

Optional Equipment

With approximate changes in operating weights. Optional equipment may vary. Consult your Cat dealer for specifics.

POWER TRAIN

- -50° C (-58° F) antifreeze
- Engine oil change system, high speed, Wiggins
- Engine block heater 120V or 240V
- High ambient cooling – software
- Cat Production Measurement
- Crankcase guard

OPERATOR ENVIRONMENT

- Cab precleaner
- AM/FM/CD/MP3 radio
- Satellite Sirius radio with Bluetooth®
- LED warning strobe
- Window pull down visor
- Handrail mounted mirrors

MISCELLANEOUS ATTACHMENTS

- Front and rear roading fenders
- Fast fill fuel system (Shaw-Aero)
- Cold Weather Starting (extra starter plus two batteries)
- Aggregate Handler
- Tire Pressure Monitoring System

988K XE Mandatory Attachments

Mandatory Attachments

Select one from each group. Mandatory and optional equipment may vary. Consult your Cat dealer for specifics.

LINKAGE

- Standard with two valves
- High Lift with two valves

- Autolube
- Manual grease pins

ELECTRICAL

- Product Link (Satellite)
- Product Link (Cellular)

STEERING

- Standard steering
- Secondary steering

POWER TRAIN

- Axle oil cooler
- Standard axles

- Standard fuel lines
- Heated fuel lines

- Standard axle
- No spin axle
- Extreme temperature axle

- Standard engine air turbine precleaner
- Dual stage precleaner

- No engine brake
- Engine brake

LIGHTING

- Standard lighting
- HID lighting
- LED lighting

OPERATOR ENVIRONMENT

- Standard cab glass
- Rubber mounted cab glass

- Fixed glass door, standard
- Sliding glass door

- Standard cab air cleaner
- RESPA cab air cleaner

- Standard mirror
- Heated mirror

- Rear vision display
- Rear vision display with Cat Detect (Object Detection)

HYDRAULICS

- Ride control
- No ride control

- Standard hydraulic oil
- Cold weather hydraulic oil

For more complete information on Cat products, dealer services, and industry solutions, visit us on the web at www.cat.com

AEHQ8060 (08-2017)

© 2017 Caterpillar
All rights reserved

Materials and specifications are subject to change without notice. Featured machines in photos may include additional equipment. See your Cat dealer for available options.

CAT, CATERPILLAR, SAFETY.CAT.COM, their respective logos, "Caterpillar Yellow" and the "Power Edge" trade dress, as well as corporate and product identity used herein, are trademarks of Caterpillar and may not be used without permission.

